



TVS 3690 TV Floor Stand (black)

Key Benefits

- Watch TV from anywhere in the room
- Easily adjustable in height, even with your TV mounted
- Designed for TVs up to 77" and max. 50kg
- Smoothly turn your TV up to 90°
- Neatly hide your cables on the back of the stand

A TV floor stand for flexible placement

Introducing Vogel's TVS 3690, the ultimate flexible, free-standing TV floor stand. Easily adjust and position your TV thanks to our safe, sturdy, and stylish design. Built with premium steel, the TVS 3690 is ideal for almost all TVs from 40"-77", and up to 50kg.

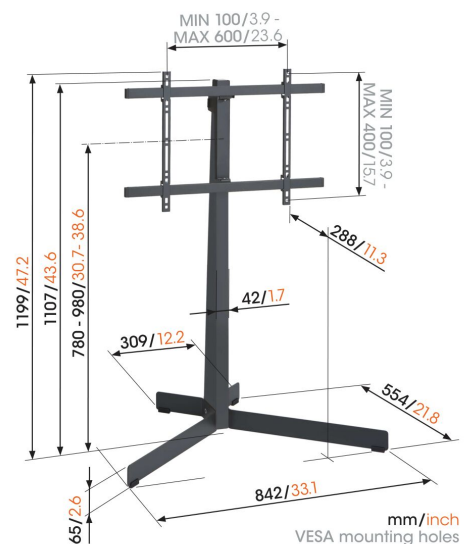



TVS 3690 TV Floor Stand (black)



Specifications

Article number (SKU)	3836900
Colour	Steel (black)
EAN single box	8712285355189
Product size	L
Height	1100
Width	842
Depth	554
TÜV certified	Yes
Turn	Up to 90°
Guarantee	10 years
Min. screen size (inch)	40
Max. screen size (inch)	77
Max. weight load (kg)	50
Min. hole pattern	100mm x 100mm
Max. hole pattern	600mm x 400mm
Max. bolt size	M8
Max. height of interface (mm)	430
Max. width of interface (mm)	660
Cable management	Integrated cable management
Max. horizontal hole pattern (mm)	600
Max. vertical hole pattern (mm)	400
Number of pivot points	1
Universal or fixed hole pattern	Universal

VOGEL'S HOLDING BV (c)

All rights reserved.
Subject to printing errors,
technical and price
amendments.

Date: 2022-02-17



Vogel's. For Sure.