

SONY

4K Home Theater Projector

VPL-VW1100ES





The Ultimate 4K Home Cinema Experience

The VPL-VW1100ES projector is our leading, luxury 4K home theater projector. It gives you the fully immersive experience of digital cinema in a large, dedicated screening space. With astonishing 4K resolution (4x the quality of Full HD) and a multitude of advanced features, it's our most 'professional' home theater projector yet.

4K

Features

No-compromise 4K Native Resolution:

More Than 4x Full HD Images

The VPL-VW1100ES 4K home theater projector offers DCI-based* 4096 x 2160 resolution, more than four times the resolution of Full HD. The projector's 4K SXRDTM panels have been specially developed by Sony for the VPL-VW1100ES, utilizing 4K expertise from the professional cinema market. These panels deliver a native 4K picture, with no electronic enhancement of pixels.

*Digital Cinema Initiatives: The standard of digital cinema distribution.

2,000 Lumens for Vibrant Images

With 2,000-ANSI-lumen brightness, the VPL-VW1100ES delivers nearly twice the output of Sony's previous home theater projectors. Combined with 4K SXRDTM panels, this projector is able to offer both higher brightness and a higher contrast ratio for optimum viewing in the home environment.

Remarkable Dynamic Contrast for Highest Picture Quality

The projector's 4K native SXRDTM panels produce outstanding native device contrast, reproducing deep blacks by improving the flatness level of the pixel surface. When combined with Sony's Advanced Iris3 technology, this projector can achieve an incredible 1,000,000:1 dynamic contrast for the best ever images.



Richer Pictures with Wide Color Space (DCI*, Adobe RGB)

The VPL-VW1100ES offers a wider-than-normal color space, enabling it to show the fuller color information provided by the professional DCI color specification and the Adobe RGB color space.

*Digital Cinema Initiatives: The standard of digital cinema distribution.

TRILUMINOSTM Display Technology

The VPL-VW1100ES's optical engine and SXRDTM panels incorporate our TRILUMINOS Display technology to produce a much broader color range, reproducing more tones and textures than a standard projector system. The result is greater purity, depth and realism.

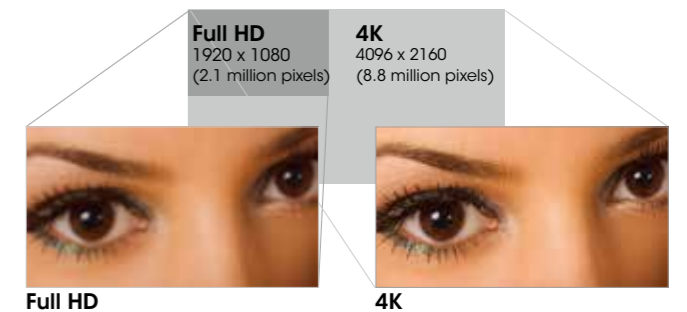

Simulated images

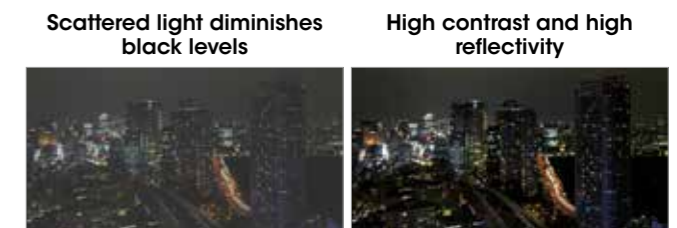
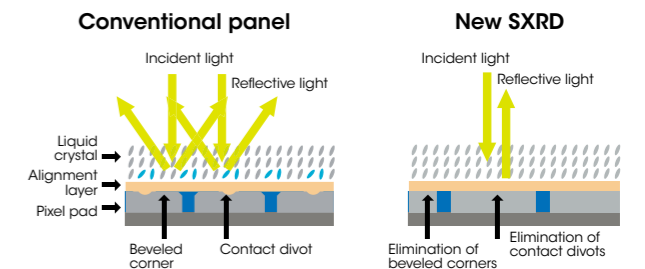

Simulated images



Simulated images

Features

Lens Optimized for 4K Images

To achieve optimized 4K images, Sony has developed the 4K All-Range Crisp Focus (ARC-F) lens specifically for the VPL-VW1100ES projector. By incorporating this super high-resolution lens, high precision and detail are seen in all corners of the image. Both Full HD SXRD projector lens technology from Sony and 4K digital cinema technology from Sony are included in the 4K ARC-F lens. In addition, this lens offers very high resolving capability, and the high-resolution image on the 4K panel can be projected correctly.

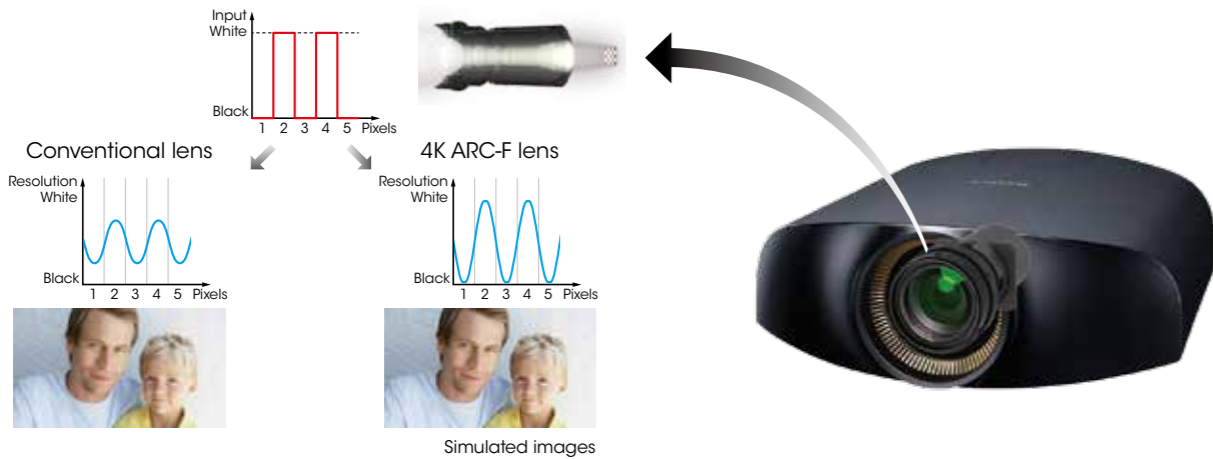

-Structure

An 18-piece lens structure is used, similar to that of a 4K digital cinema projector.

-Floating focus system

By moving the floating lens group and focusing lens group simultaneously, the floating focus system corrects any curved field occurring at the time of focal adjustment of images. Thanks to this system, high precision and high picture quality are realized in every corner of the image.

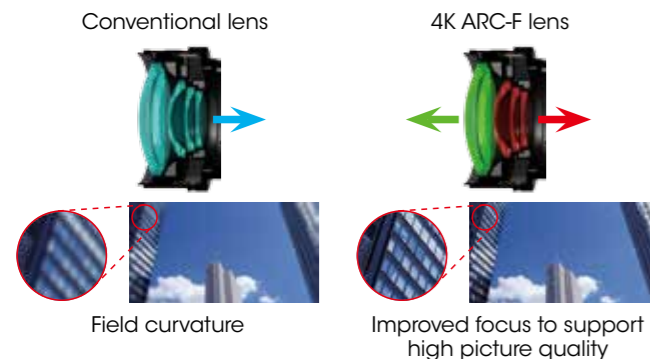
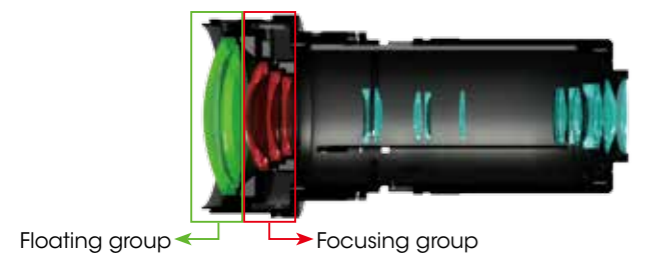

-Extra low dispersion glass

By adopting extra low dispersion glass – which provides an optimized refractive index for green, red, and blue light – clear and crisp images can be achieved.

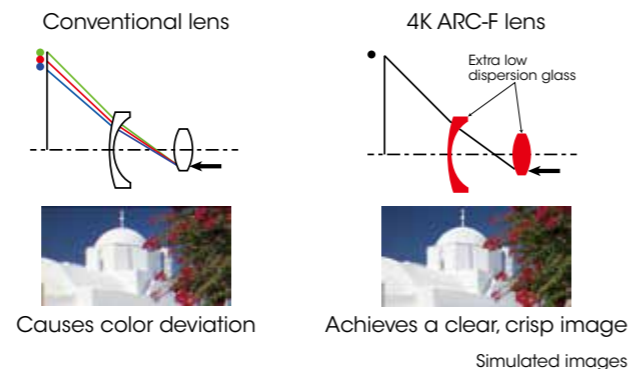
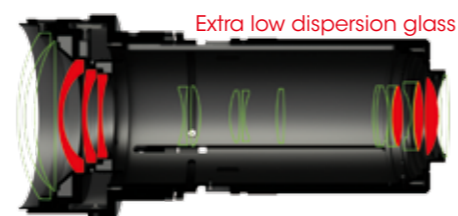

Features

"Reality Creation" 4K Upscaling

In addition to supporting 4K native resolution, the VPL-VW1100ES projector features an exclusive super-resolution 4K upscaler, "Reality Creation", which dramatically enhances high-definition 1080p content, allowing viewers to get the most from their existing Blu-ray Disc™ libraries at home. For greater versatility, it can also display Full HD 3D and 4K upscaling of 3D movies.

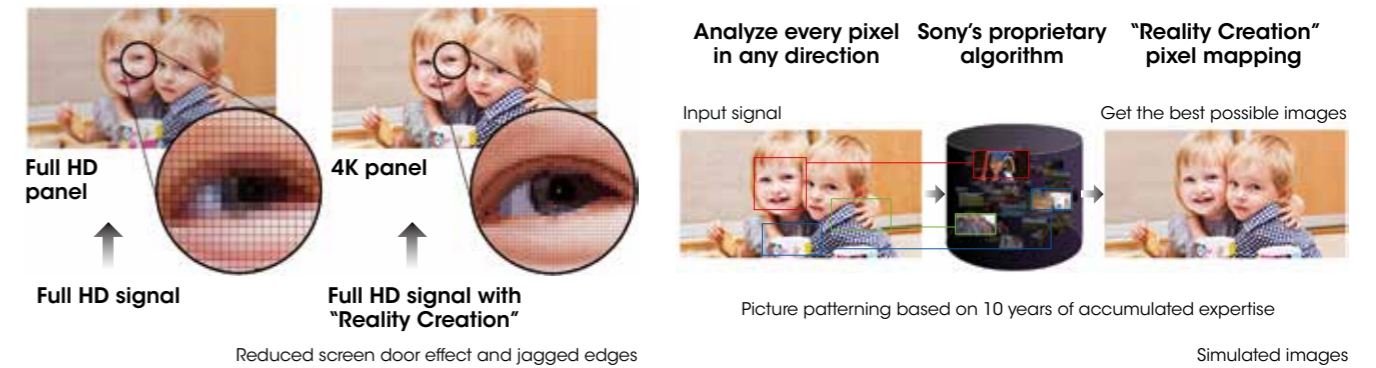

Compatible with 'Mastered in 4K' Blu-ray Discs

Drawing on the same technology used to downscale 4K material for Full HD, the VPL-VW1100ES gives you a near native 4K experience with discs 'Mastered in 4K'. It's as close as you can get to the 4K-pixel resolution and expanded color range of the original.

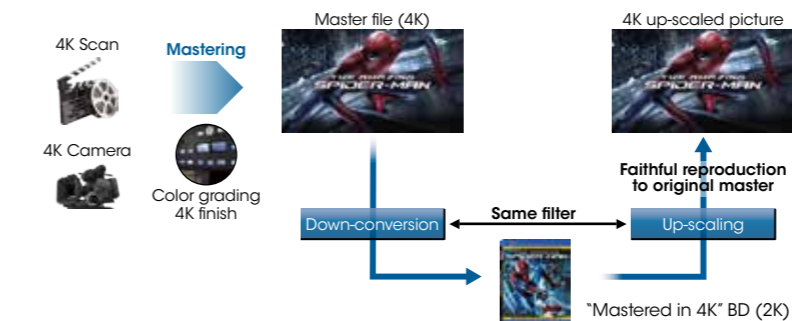

The Amazing Spider-Man™ now available on Blu-ray Disc™
The Amazing Spider-Man © 2012 Columbia Pictures Industries, Inc. All Rights Reserved. | Marvel, and the names and distinctive likenesses of Spider-Man and all other Marvel characters:™ and © 2013 Marvel Entertainment, LLC & its subsidiaries. All Rights Reserved.

Simulated images

Widescreen Friendly

The VPL-VW1100ES delivers a widescreen-friendly resolution of 4096 x 2160 based on the DCI specification. This means viewers can enjoy movies without annoying black bars at the top and bottom of the screen.

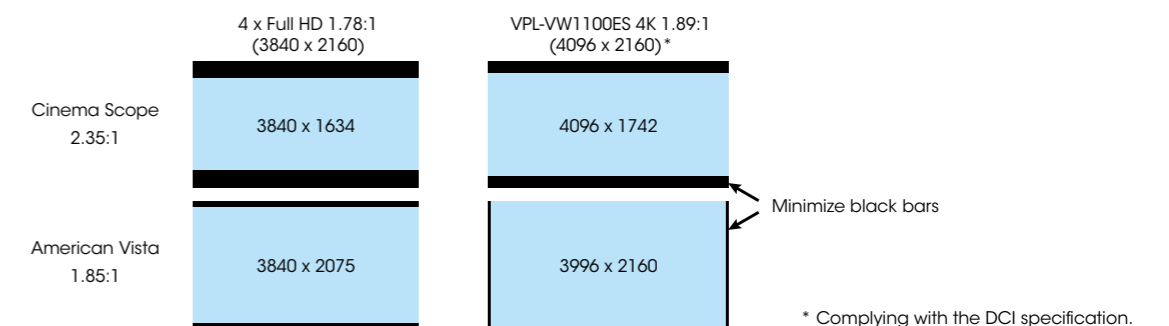



Features

Picture Position Memory Matches Movie Aspect Ratio

The VPL-VW1100ES has a picture position memory, which memorizes the position of the lens (focus, zoom, shift). Users can match a movie's aspect ratio, including 1.78:1 and 2.35:1, and store these settings in the projector for easy recall.

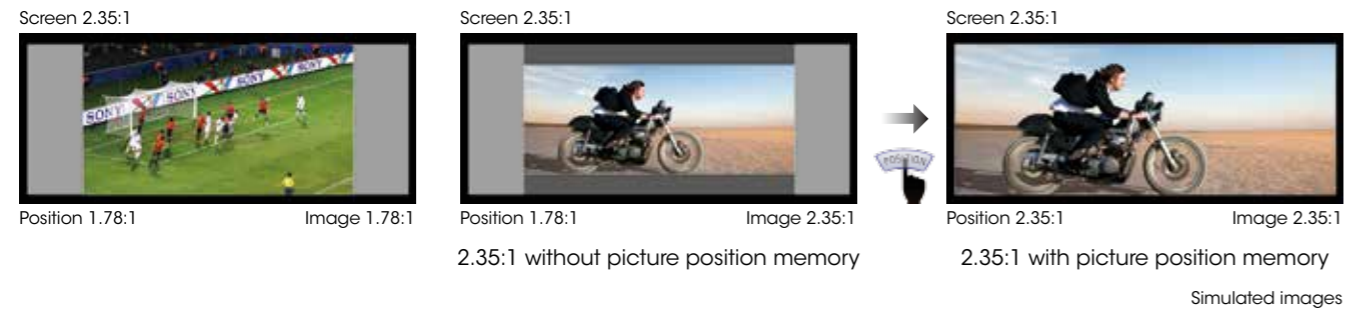

Cool and Functional Design

Combining hallmark styling with high-dimensional balance, the VPL-VW1100ES unit succeeds at being both cool and functional.



Lens Protector

The protector opens/closes automatically, keeping the lens dust-free, and is synchronized with the projector powering on/off.



Immersive 4K Upscaling 3D

-Improved emission power for built-in 3D transmitter

The projector has a built-in 3D transmitter to synchronizes 3D glasses, which alleviates the need for a cable. The emission power of the transmitter has also been boosted by 30% compared to previous models, allowing much wider coverage of the 3D signal.



-2D to 3D conversion

Sony is leading the way in creating an ever-growing selection of movies, sports, and TV programs in 4K 3D detail. Sony's 3D projectors also convert 2D pictures into 3D, so viewers can even enjoy classic movies in this whole new viewing dimension.

-Simultaneous anamorphic and 3D viewing

The VPL-VW1100ES is able to display anamorphic images and 3D without requiring a lens change, making it as user-friendly as possible.

Features

Experience Blur-free Action with Motionflow

To bring the thrill of watching fast-paced, cinematic action to the home, the VPL-VW1100ES features a technology called Motionflow, which makes motion much smoother. This innovative process creates and inserts artificial frames, first comparing key visual factors on successive frames, and then calculating the split second of 'missing' action in the sequence. This action mimics that of actual movie projection, so viewers experience movies and sports with a greater sense of realism than ever before.



Powerful Picture Calibration

Powerful features allow viewing in a dark room as well as a room with ambient light. Users can quickly select the right picture calibration for each type of content, with nine unique modes including a variety of pre-sets: cinema film1, cinema film2, cinema digital, reference, TV, photo, game, bright cinema, and bright TV.

Panel Alignment Function

To ensure the best possible results, all models feature electronic panel alignment, allowing the user to achieve an exact alignment of the red and blue elements within each pixel. Adjustments can be made by as little as 0.1 pixels to achieve optimum clarity.

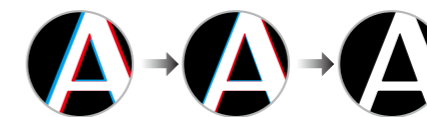

Whisper-quiet Operation

The VPL-VW1100ES incorporates the latest noise-reduction technology, including a whisper-quiet fan, to minimize projector sound as much as possible.

Optional Accessories



* 2x 3D glasses bundled with the VPL-VW1100ES.

Specifications

		VPL-VW1100ES
Optical		
Light Output		2000 lumens
LCD Panels		0.74" x3 SXRD Panel
Panel Display Resolution		4096 x 2160 dots
Contrast Ratio*1		1,000,000:1 (Dynamic Contrast)
Light Source		Ultra High Pressure Lamp 330 W type
Recommended Lamp Replacement Time*2		2000 H (Lamp mode: High) 2500 H (Lamp mode: Low)
Projection	Zoom / Focus	Approx. 2.1x Powered Zoom / Powered Focus
Lens	Lens Shift	Powered, Vertical +/- 80%, Horizontal +/- 31%
	Throw Ratio	1.27:1 to 2.73:1
Screen Size		60" to 300"
Interface		
Input / Output	HDMI (2 inputs)	Digital RGB/Y Pb/Cb Pr/Cr
	Y Pb/Cb Pr/Cr	Component: phono type
	INPUT A	Mini D-sub 15-pin (RGB)
	Trigger (2 connectors)	Mini Jack, DC 12 V Max. 100 mA
	Remote	RS232C, D-sub 9-pin (female)
	LAN	RJ45, 10BASE-T/100BASE-TX
	IR IN	Mini Jack
	3D Sync	RJ45 / Built-in transmitter
General		
Scanning Frequency		H: 19 to 72 kHz, V: 48 to 92 Hz
Display Resolution (Digital Input)		480/60p, 576/50p, 720/60p, 720/50p, 1080/60i, 1080/50i, 1080/60p, 1080/50p, 1080/24p, 3840 x 2160/24p, 3840 x 2160/25p, 3840 x 2160/30p, 3840 x 2160/50p*, 3840 x 2160/60p*, 4096 x 2160/24p, 4096 x 2160/25p, 4096 x 2160/30p, 4096 x 2160/50p*, 4096 x 2160/60p*
Power Requirements		AC 100 V to 240 V, 4.8 A to 2.0 A, 50 Hz/60 Hz
Power Consumption		480 W (AC 100 V)
		470 W (AC 120 V)
		460 W (AC 220 V-240 V)
Standby Mode Power Consumption		3.5 W (Std) / 0.3 W (Low) (AC 100 V)
		3.5 W (Std) / 0.3 W (Low) (AC 120 V)
		3.9 W (Std) / 0.4 W (Low) (AC 220 V-240 V)
General		
Dimensions (WxHxD) (without protrusion)		520 x 200 x 640 mm
		20 1/2 x 7 7/8 x 25 1/4 inches
Mass		20.0 kg / 44 lb 1.5 oz
Service Parts		
Replacement Remote		1-490-070-11 (RM-PJ22)

*1 The value is average.

*2 The figures are expected maintenance time and not guaranteed.

They will depend on the environment or how the projector is used.

*3 Available only for YUV 4:2:0 / 8-bit format signal.

Control Panel

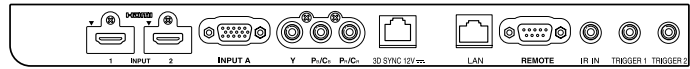

Dimensions

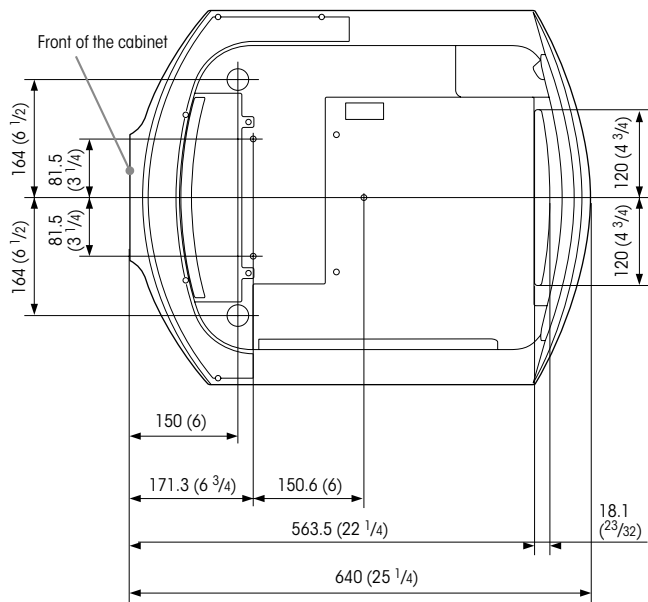
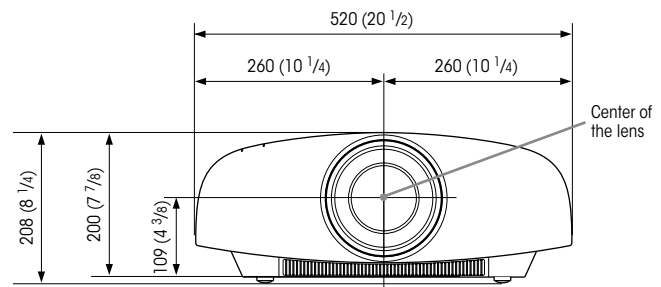

Distributed by

©2014 Sony Corporation. All rights reserved.

Reproduction in whole or in part without written permission is prohibited. Features and specifications are subject to change without notice.

The values for mass and dimension are approximate. "SONY", "SXRD", "Motionflow", "TRILUMINOUS", "24p True Cinema", and "3D World" are trademarks of Sony Corporation.

The terms HDMI and HDMI High-Definition Multimedia Interface, and the HDMI Logo are trademarks or registered trademarks of HDMI Licensing LLC in the United States and other countries. All other trademarks are the property of their respective owners.